



Teachers' Notes

Curricular links to Health Education 5-14 National Guidelines and RSE Guidelines

Attainment outcome: Taking responsibility for health

LEVEL B

STRAND	ATTAINMENT TARGET	RSE GUIDELINES
Physical health This strand explores physical factors in relation to our health and looking after ourselves.	Identify a range of ways of keeping safe e.g. safe road use.	Green Cross Code.

Teaching Background Information

Safer places to cross the road

Pedestrians should, where possible, cross the road:

- ➔ At a pelican crossing.
- ➔ At a zebra crossing.
- ➔ At traffic lights.
- ➔ Where there is a traffic island in the road.
- ➔ At crossings controlled by school crossing patrollers, police officers or traffic wardens.



Unsafe places to cross the road

Pedestrians should not cross the road:

- ➔ On a bend because you cannot see vehicles approaching.
- ➔ Near parked vehicles because it is difficult to see approaching vehicles and there is the danger of vehicles reversing into pedestrians.
- ➔ On the brow of a hill because you cannot see vehicles approaching.
- ➔ At a road junction because it is difficult to check for vehicles approaching from all directions.

If you would like more details refer to the Teaching Background Information in Activity B2.

Useful Websites

www.hedgehogs.gov.uk/arrivealive

www.saferoutestoschools.org.uk

www.walktoschool.org.uk



Suggested Lesson Plan

Aims

- ➔ To show the safest places to cross the road.

Learning Outcomes

- ➔ Understand that there are safer places to cross the road.
- ➔ Understand the reasons why certain places are safer.
- ➔ Contrast with unsafe places to cross the road.



Resources

- ➔ Worksheet B1a – Safer Places to Cross the Road.
- ➔ Worksheet B1b – Safer Places to Cross the Road.
- ➔ Photo of a traffic island.
- ➔ Photo of a road with a bend in it.
- ➔ Glossary.
- ➔ Word Flashcards.



Suggested Timing

- ➔ 40 minutes.

Suggested Development of Lesson

- ➔ Recap on safer places to cross the road (Level A).
- ➔ As a class or in groups brainstorm safer places to cross the road. Show the photo of the traffic island (showing a safe place to cross the road) and the photo of the road with a bend in it (showing an unsafe place to cross the road) to generate discussion.
- ➔ Collect ideas and write up on the board.
- ➔ Distribute Worksheet B1a or B1b as appropriate, explain the task and allow children time to complete.
- ➔ As a class discuss and assess the completed worksheet.



Suggested Lesson Plan



Assessment

- ➔ Correct completion of worksheet (see answers).

Curricular Links

- ➔ English Language: Talking: Talking in groups.
- ➔ English Language: Listening: Listening in groups.

Follow-up/Homework Activities

- ➔ Safety Street CD – see Safety Street sheet for details (see following page).



Safety Street Primary 3, 4 and 5

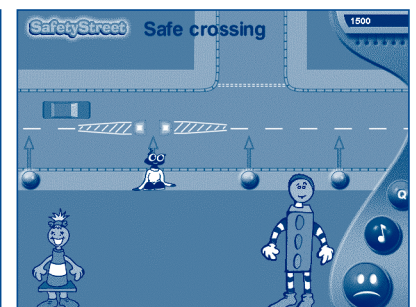
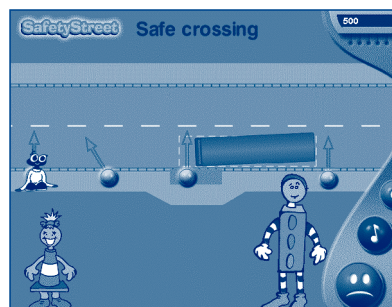
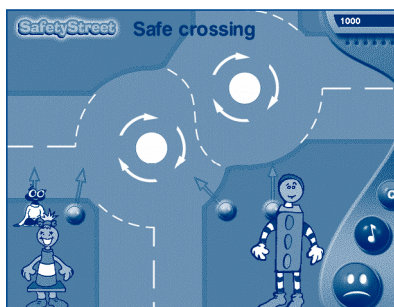
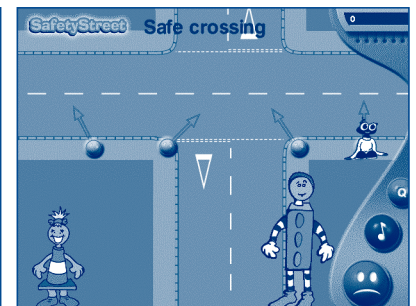
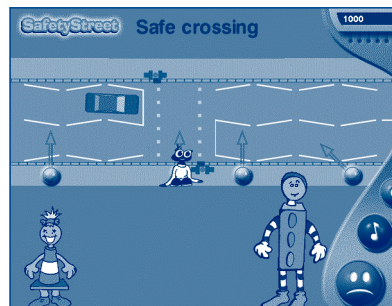
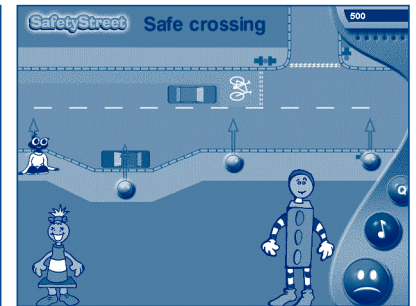
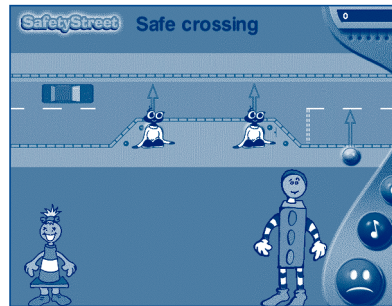
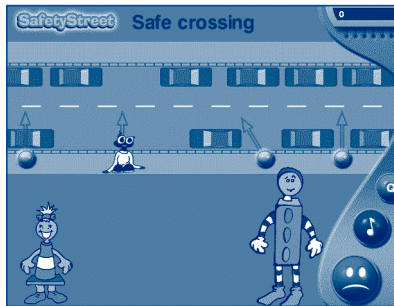
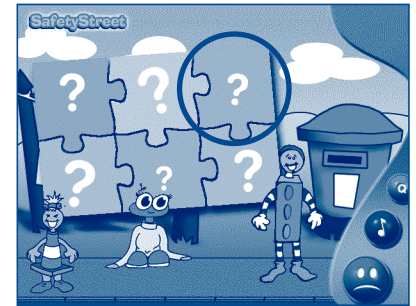

The alien is in the safest position in each picture.





Name: _____ Date: _____

AIM:
You are going to learn
about safer places to
cross the road.

TASK

3 of these pictures show safer places to cross the road.

1. Cut out the 3 'safer' and 3 'unsafe' words from the bottom of the page.
2. Stick them on the right pictures.

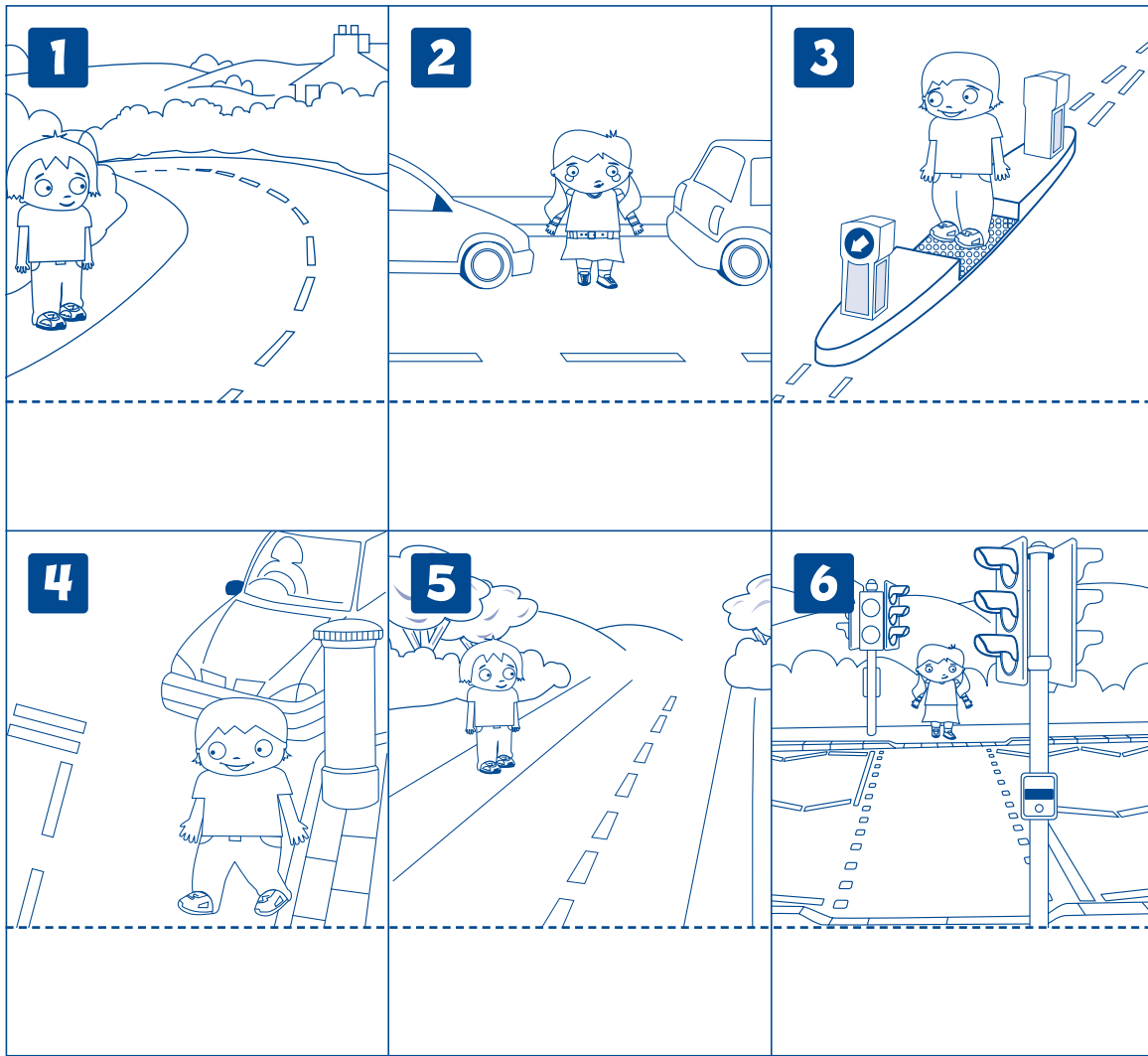

EXTRAS



1. Colour in the people who are crossing the road in a safer place in green.
2. Colour in the people who are crossing the road in an unsafe place in red.
3. On the back of this sheet explain what is safe or unsafe about the pictures.
4. Colour in the rest of the pictures.

REMEMBER
Always find a safer place
to cross the road.

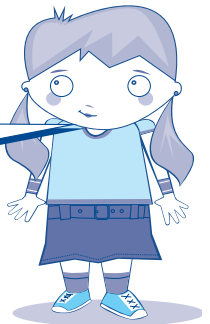

safer

safer

safer

unsafe

unsafe

unsafe

Pupil Activities Answers

3 of these pictures show safer places to cross the road.

AIM:
You are going to learn
about safer places to
cross the road.

TASK

1. Cut out the 3 'safer' and 3 'unsafe' words from the bottom of the page.
2. Stick them on the right pictures.

<p>1</p>	<p>2</p>	<p>3</p>
<p>unsafe</p>	<p>unsafe</p>	<p>safer</p>
<p>4</p>	<p>5</p>	<p>6</p>
<p>unsafe</p>	<p>safer</p>	<p>safer</p>

EXTRAS



1. Colour in the people who are crossing the road in a safer place in green.
2. Colour in the people who are crossing the road in an unsafe place in red.
3. On the back of this sheet explain what is safe or unsafe about the pictures.
4. Colour in the rest of the pictures.

REMEMBER
Always find a safer place
to cross the road.

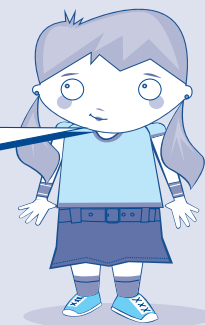

safer

safer

safer

unsafe

unsafe

unsafe

Name: _____

Date: _____



AIM:
You are going to learn
about safer places to
cross the road.

3 of these pictures show safer places to cross the road.

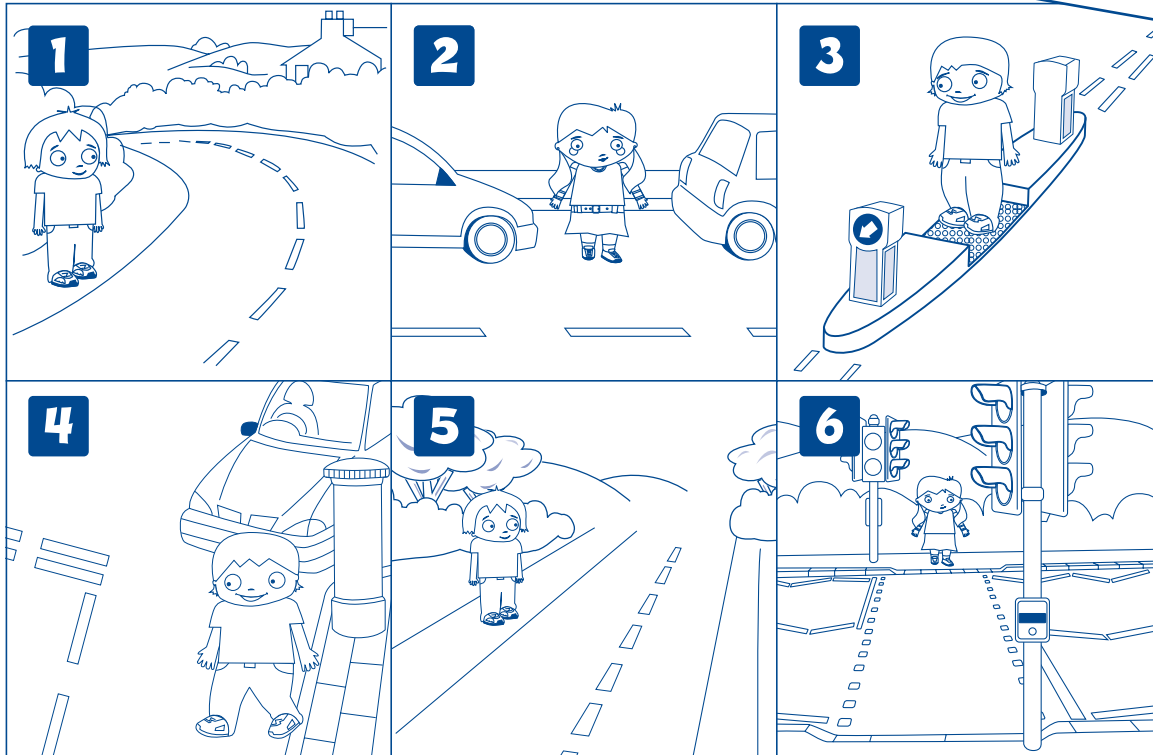

TASK

Picture _____ shows a safer place to cross the road because

Picture _____ shows a safer place to cross the road because

Picture _____ shows a safer place to cross the road because

EXTRAS



1. Colour in the people who are crossing the road in a safer place in green.
2. Colour in the people who are crossing the road in an unsafe place in red.
3. Colour in the rest of the pictures.
4. On the back of this sheet explain what is unsafe about the other pictures.

REMEMBER
Always find a safer
place to cross the road.

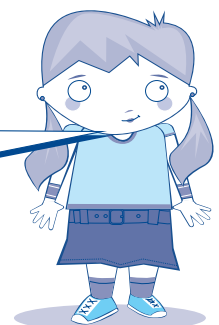

Pupil Activities Answers

AIM:
You are going to learn
about safer places to
cross the road.

3 of these pictures show safer places to cross the road.

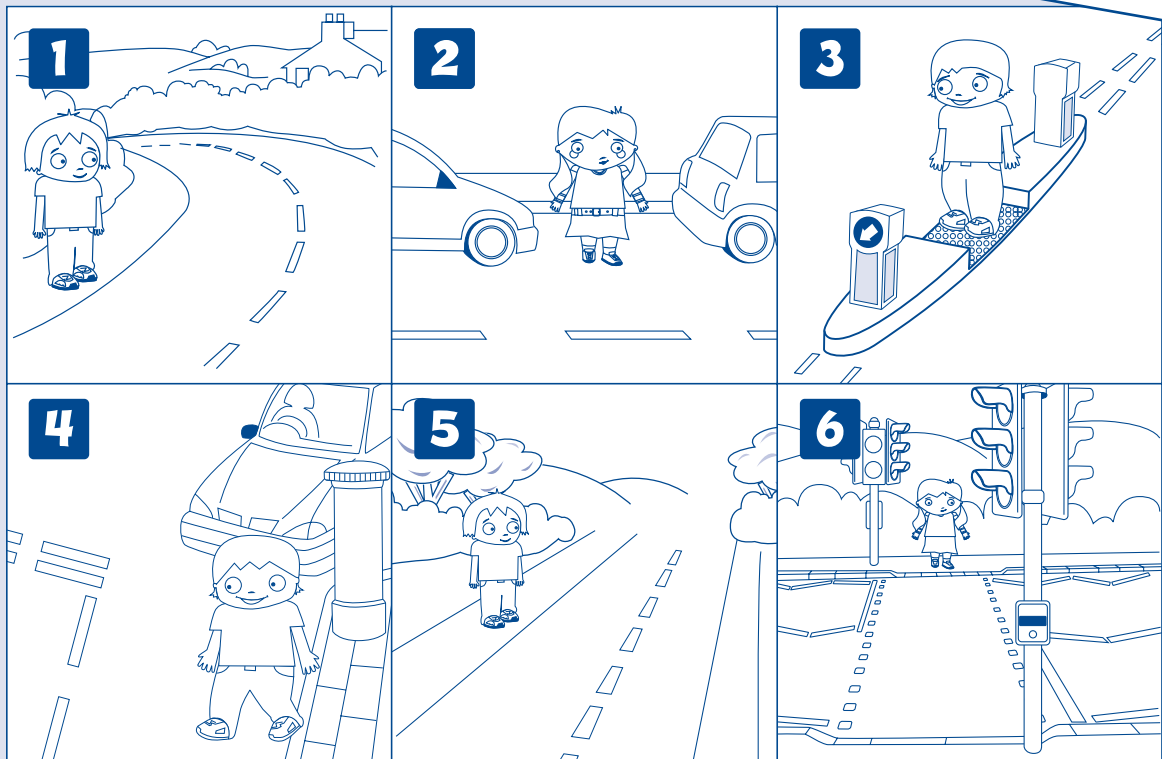

TASK

Picture 3 shows a safer place to cross the road because

Pedestrian is using a traffic island because they can cross one half of the road and then the other.

Picture 5 shows a safer place to cross the road because

Pedestrian is on a straight stretch of road helping them see further.

Picture 6 shows a safer place to cross the road because

Pedestrian is using a pelican crossing.

EXTRAS



1. Colour in the people who are crossing the road in a safer place in green.
2. Colour in the people who are crossing the road in an unsafe place in red.
3. Colour in the rest of the pictures.
4. On the back of this sheet explain what is unsafe about the other pictures.

REMEMBER
Always find a safer
place to cross the road.

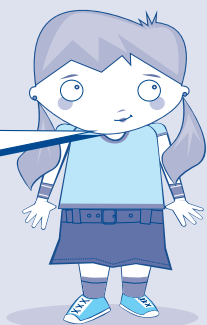

Pupil Activities Answers

Unsafe places

Picture 1 – Rural road crossing on a bend is unsafe because you cannot see traffic coming from around the bend.

Picture 2 – Crossing between parked cars is unsafe because you cannot see traffic clearly because you are between the cars.

Picture 4 – There is poor visibility because of the post box. You are also at a junction.



REMEMBER
Always find a
safer place to
cross the road.

